

1 2 3 4 5 6 7 8 9 10

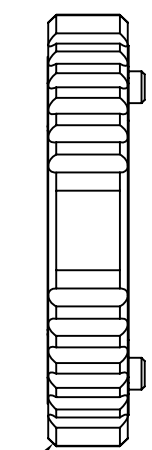

C or R0.3

NOTE:

1. ALL DIMENSION ARE IN MILLIMETERS, BRACKETED DIMENSIONS ARE IN INCHES.
2. GENERAL TOLERANCES MAX. ±0.20mm.
3. PUSH OF STROKE: 0.8mm.

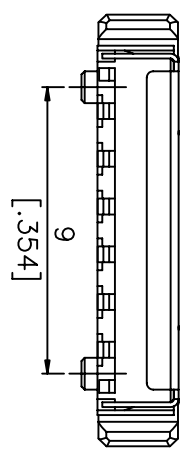
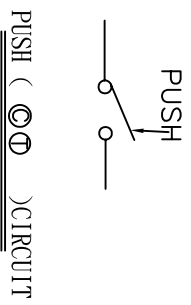
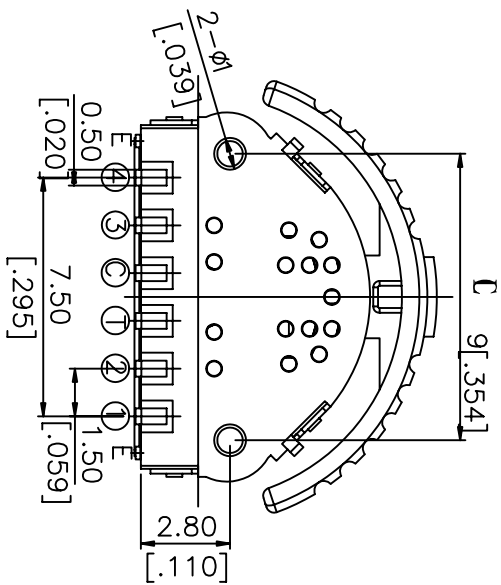
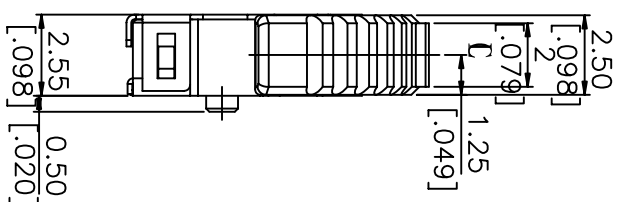
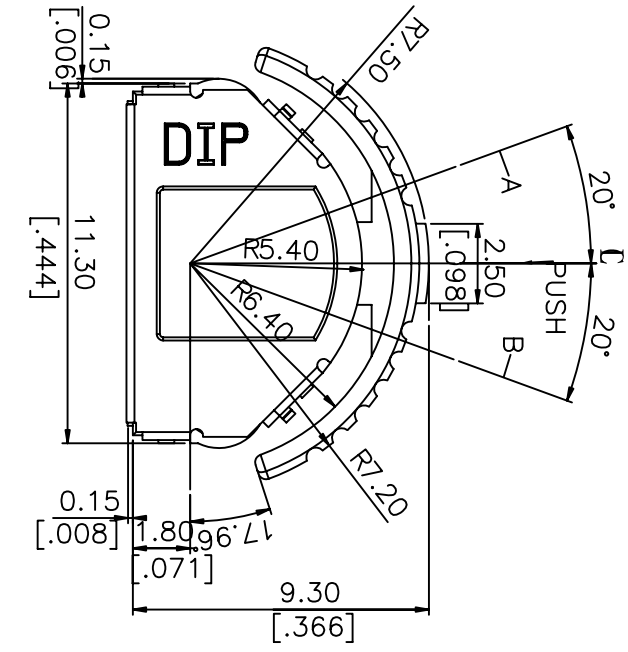
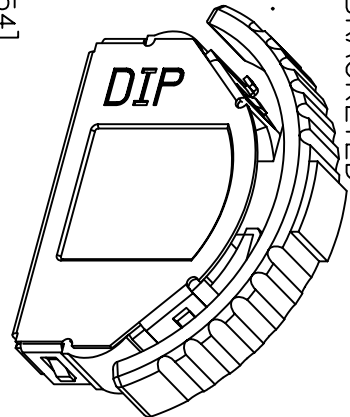

ANGLE	TERMINAL NO.	A	B
20°	(16')	(8')	(16')
①			
②			
③			
④			

*E : ERTHING TERMINAL
*■ : ON POSITION

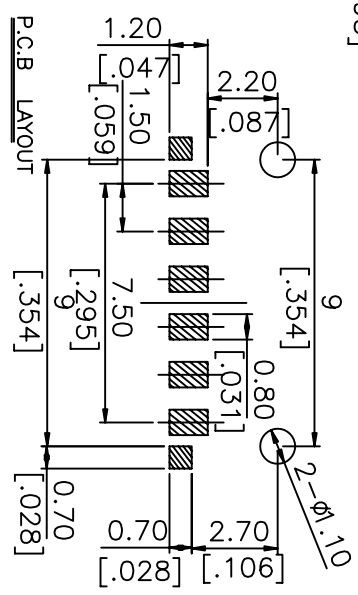

△			
△			
△	B	變更料號原PLJ-88變更為PLJ-88*	D7.25.01 李正哲
△	A	DWG.	07.09.01 李正哲
ZONREV.	DESCRIPTION	DATE	APPD

APPD:	QTY: 1	SCALE: 5:1	REV: B	UNITS: mm	PART NO: PLJ	MAT'L:	PART NAME: PLJ Assembly (Push Lever SW. Type)
CHKD:	DR: 黃昌茂	DESIGN:	FINISH:				DWG NO: R D P L
 Technology * Perfection * Service							