

1		2		3		4	
ZONE		SYMBOL		REVISION		APPROVAL	

F		E		D		C		B		A	
DATE		APPROVAL		DATE							

RoHS
Compliant

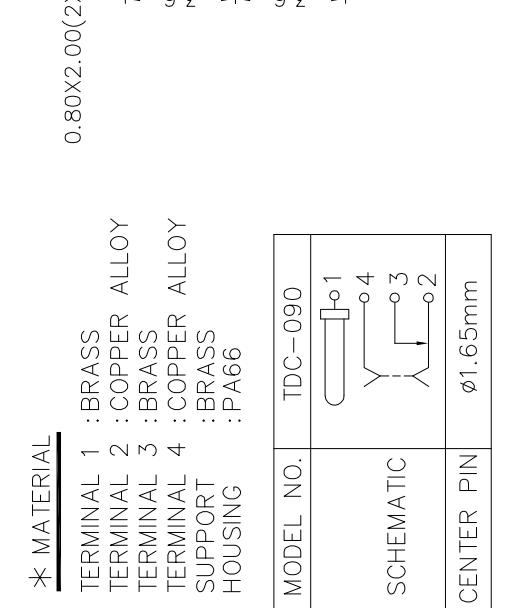
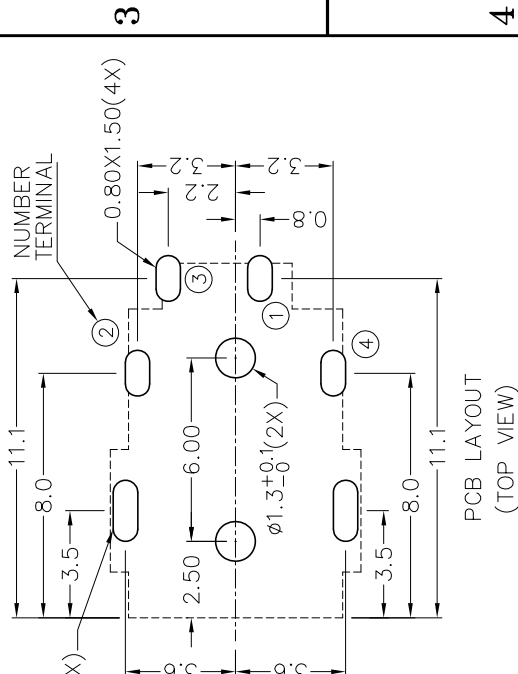
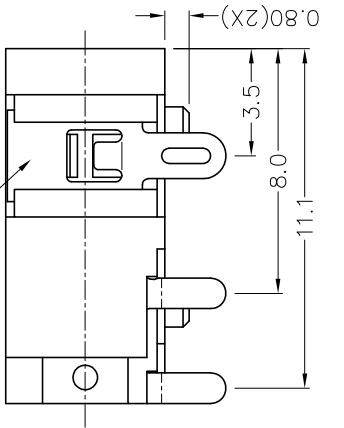
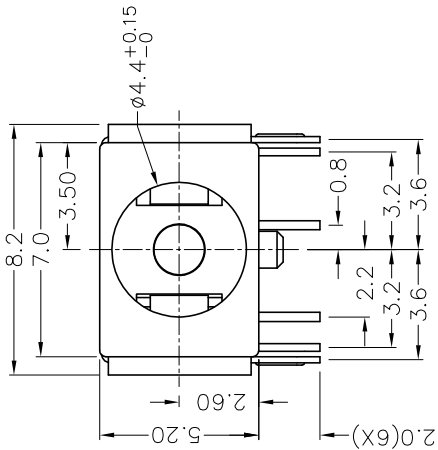
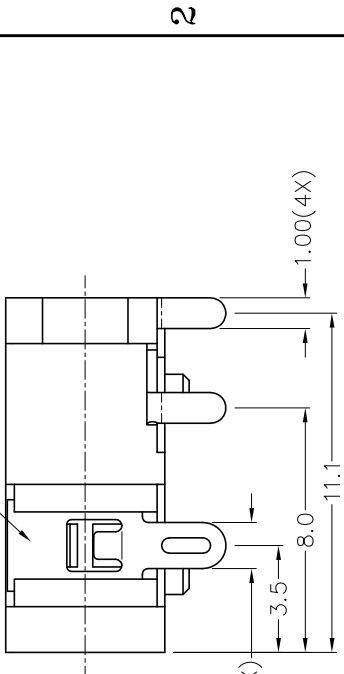
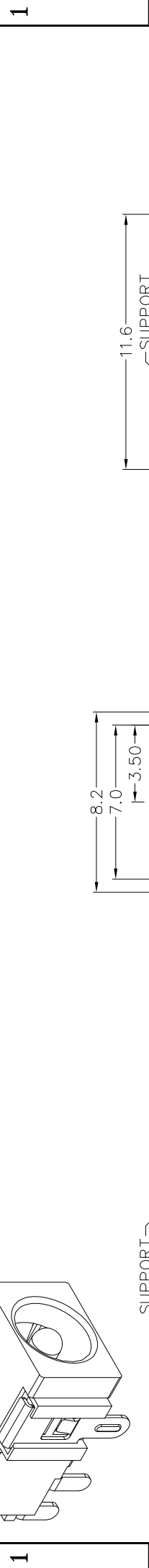

*** MATERIAL**
 TERMINAL 1 : BRASS
 TERMINAL 2 : COPPER ALLOY
 TERMINAL 3 : BRASS
 TERMINAL 4 : COPPER ALLOY
 SUPPORT : BRASS
 HOUSING : PA66

MODEL NO.	TDC-090
SCHEMATIC	
CENTER PIN	ø1.65mm

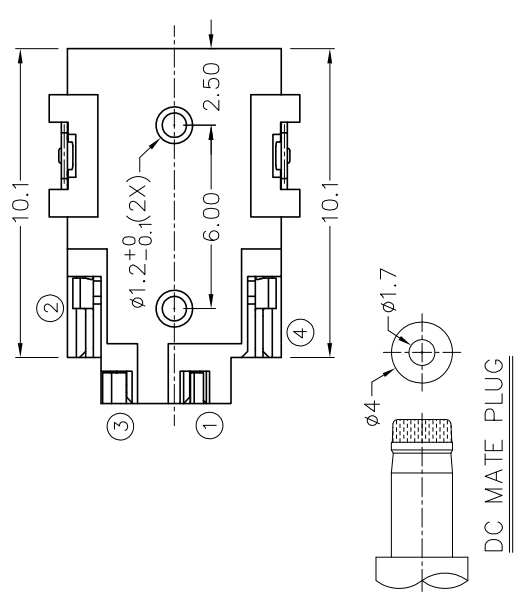

PART NAME		DC POWER SOCKET		TOLERANCE UNLESS		0.0±0.2		UNIT:		mm	
PART NO.		TDC-090		OTHERWISE SPECIFIED:		0.000±0.05					
DESIGN		G.P.YI		DATE		19-10-2010		SCALE		4:1	
DRAWING		G.P.YI		DATE		19-10-2010		MATERIAL		*	
CHECK				DATE				DWG. NO.		TZ\DC090-PA66/A	
APPROVAL				DATE				SHEET			

JOYNet Enterprise Co., Ltd.