

ROHS
Compliant

C		B		A	
ZONE	SYMBOL	REVISION	APPROVAL	DATE	

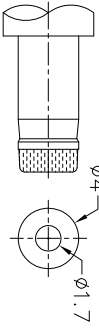
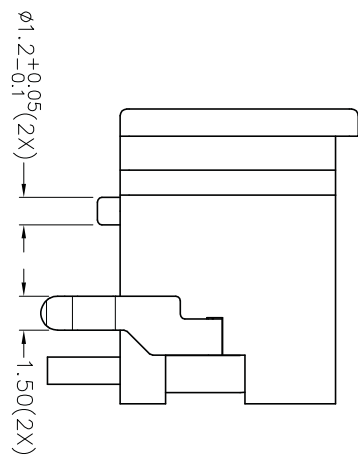
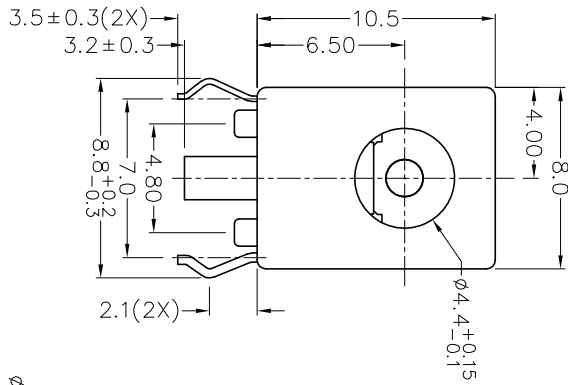
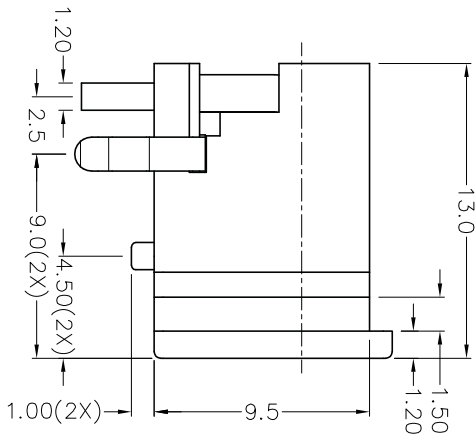
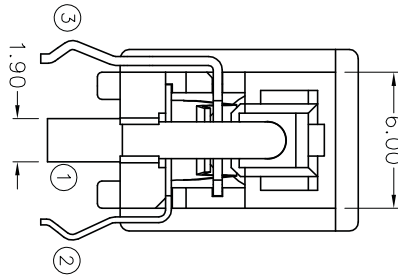
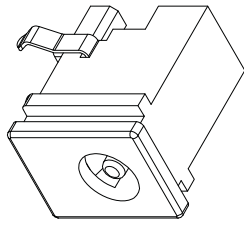

DC MATE PLUG

MODEL NO.	TDC-071
SCHEMATIC	
CENTER PIN	$\phi 1.65\text{mm}$

* MATERIAL
 TERMINAL 1 : BRASS
 TERMINAL 2 : COPPER ALLOY
 TERMINAL 3 : BRASS
 HOUSING : PBT

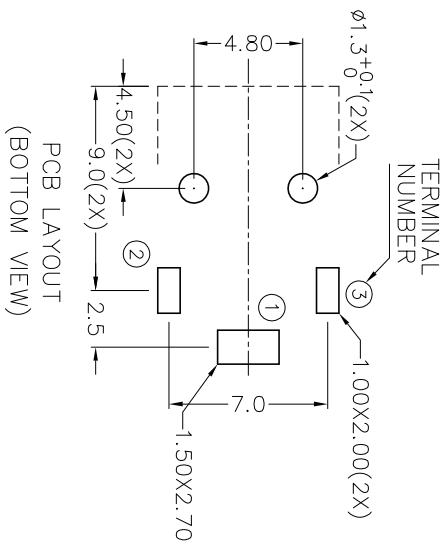

PCB LAYOUT
(BOTTOM VIEW)

PART NAME		DC POWER SOCKET		TOLERANCE UNLESS		0.0±0.2		UNIT:		mm	
PART NO.		TDC-071		OTHERWISE SPECIFIED:		0.00±0.1		0.000±0.05		mm	
DESIGN		G.P.YI		DATE		25-9-2007		SCALE		3:1	
DRAWING		G.P.YI		DATE		25-9-2007		MATERIAL		*	
CHECK				DATE				DWG. NO.		TZ\DC071-PBT/A	
APPROVAL				DATE				SHEET			



F E D C B A