

ZONE	SYMBOL	REVISION	APPROVAL	DATE

RoHS
Compliant

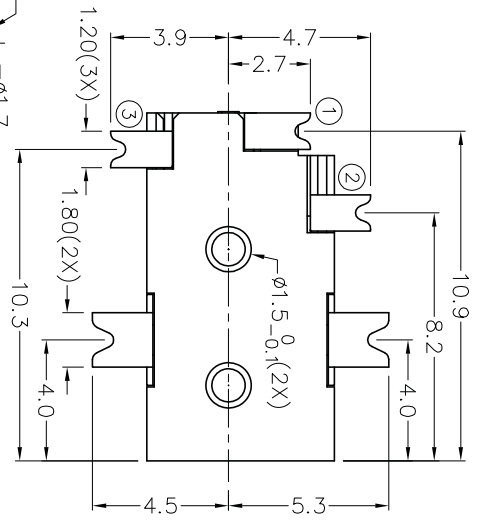
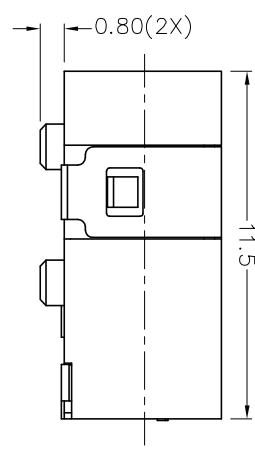
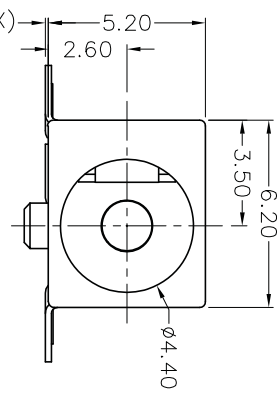
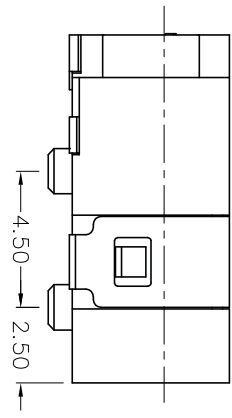
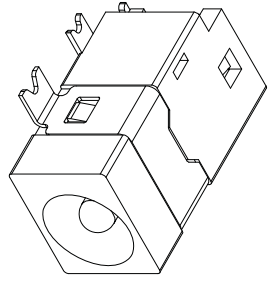

*** MATERIAL**

TERMINAL 1 : BRASS
 TERMINAL 2 : COPPER ALLOY
 TERMINAL 3 : BRASS
 SHIELD : COPPER ALLOY
 HOUSING : PA6T

MODEL NO.	TDC-068DS
SCHEMATIC	
CENTER PIN	$\phi 1.65\text{mm}$

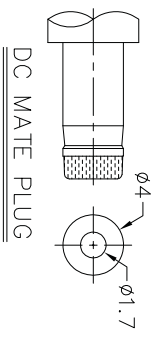
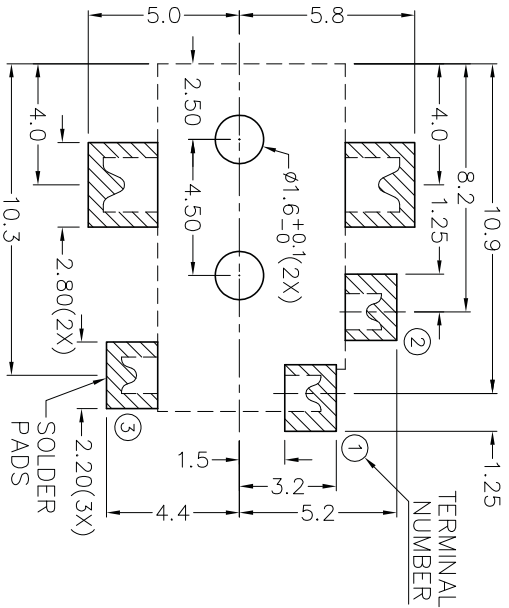

DC MATE PLUG

JOYNet Enterprise Co., Ltd.
 Technology
 Profession
 Service

PART NAME	SMD DC POWER SOCKET	TOLERANCE UNLESS	0.0±0.2	UNIT:	mm	DESIGN	T.Y.LI	DATE	20-10-2006	SCALE	4:1
PART NO.	TDC-068DS	OTHERWISE SPECIFIED:	0.00±0.1 0.000±0.05			DRAWING	T.Y.LI	DATE	20-10-2006	MATERIAL	*
						CHECK		DATE		DWG. NO.	TZY\DC068DS-P A6T/A
						APPROVAL		DATE		SHEET	

F

E

D

C

B

A

DCF-04/A