

**F**      **E**      **D**      **C**      **B**      **A**

ZONE		SYMBOL		REVISION		APPROVAL		DATE	

**1**      **2**      **3**      **4**

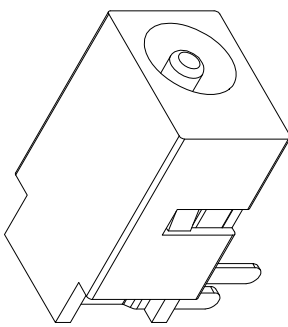

**RoHS**  
Compliant

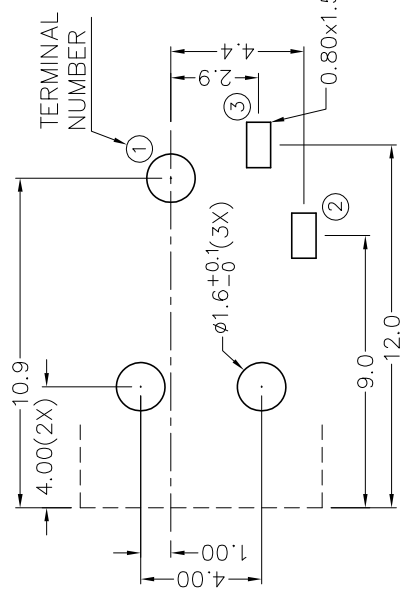
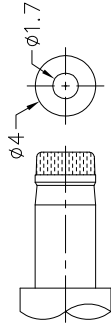
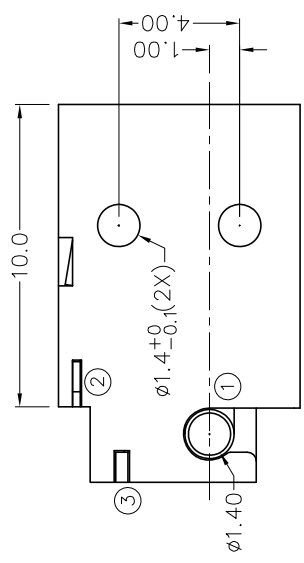
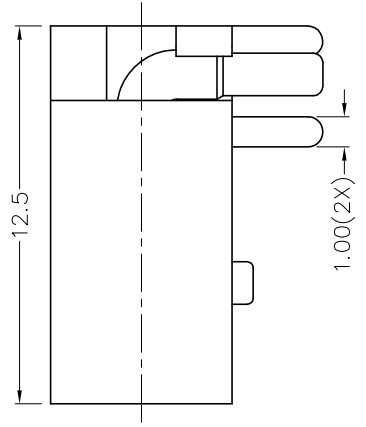
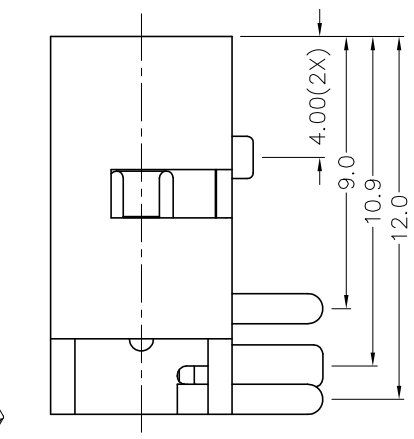
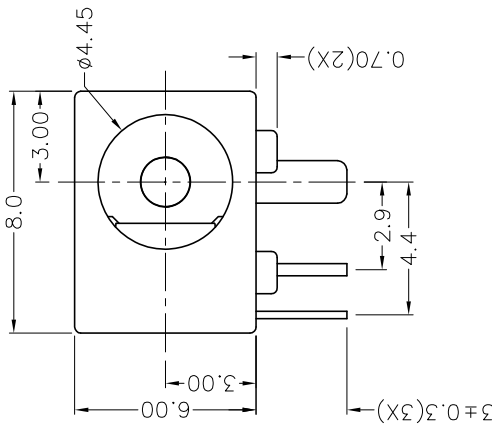

MODEL NO.	TDC-066
SCHEMATIC	
CENTER PIN	φ1.65mm

\* MATERIAL  
 TERMINAL 1 : BRASS  
 TERMINAL 2 : COPPER ALLOY  
 TERMINAL 3 : BRASS  
 HOUSING : PBT

PBC LAYOUT  
(BOTTOM VIEW)

**JOYNet Enterprise Co., Ltd.**

PART NAME	DC POWER SOCKET	TOLERANCE UNLESS	0.0±0.2	DESIGN	Z.H.LIU	DATE	25-3-2006	SCALE	4:1
PART NO.	TDC-066	OTHERWISE SPECIFIED:	0.00±0.1 0.000±0.05	DRAWING	Z.H.LIU	DATE	25-3-2006	MATERIAL	*
				CHECK		DATE		DWG. NO.	TZ\DC066-PBT/A
				APPROVAL		DATE		SHEET	
<b>F</b>	<b>E</b>	<b>D</b>	<b>C</b>	<b>B</b>	<b>A</b> DCF-04/A				