

RoHS
Compliant

ZONE	SYMBOL	REVISION	APPROVAL	DATE
		ADD MATE PLUG	J.X.KUANG	30-9-2006

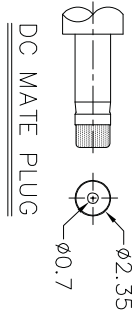
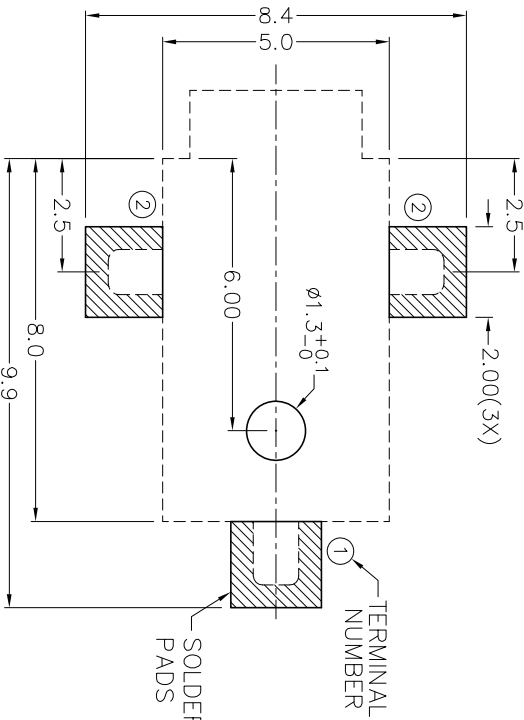
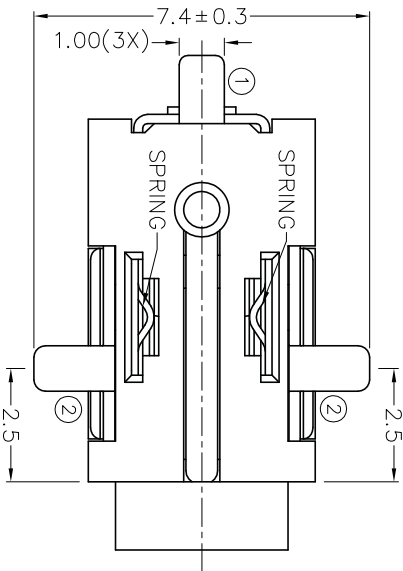
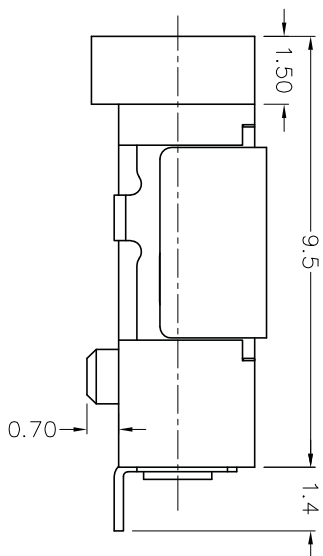
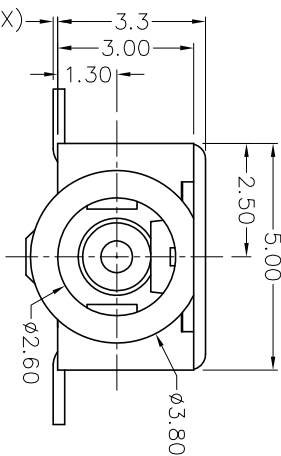
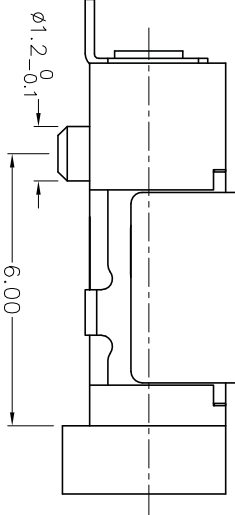
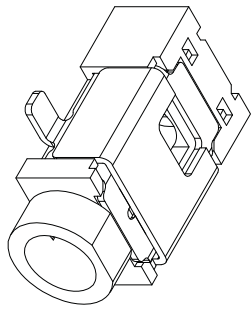

MODEL NO.	TDC-063DS
SCHEMATIC	
CENTER PIN	$\phi 0.65\text{mm}$

* MATERIAL
 CENTRE PIN : COPPER
 TERMINAL 1 : BRASS
 TERMINAL 2 : COPPER ALLOY
 SPRING : STAINLESS STEEL
 SHIELD : BRASS
 HOUSING : PA6T

JOYNet Enterprise Co., Ltd.
 Technology
 Profession
 Service

PART NAME	SMD DC POWER SOCKET	TOLERANCE UNLESS	0.0±0.2	UNIT:	mm	DESIGN	T.Y.LI	DATE	12-9-2005	SCALE	6:1
PART NO.	TDC-063DS	OTHERWISE SPECIFIED:	0.00±0.1 0.000±0.05			DRAWING	L.L.ZHANG	DATE	30-9-2006	MATERIAL	*
						CHECK		DATE		DWG. NO.	ITZ\DC063DS-PA6T/B
						APPROVAL		DATE		SHEET	

F E D C B A
 F E D C B A
 DCF-04/A