

ZONE	SYMBOL	REVISION	APPROVAL	DATE
		ADD MATE PLUG	J.X.KUANG	30-9-2006

RoHS
Compliant

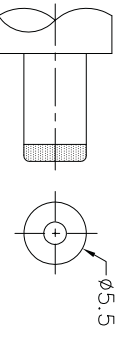
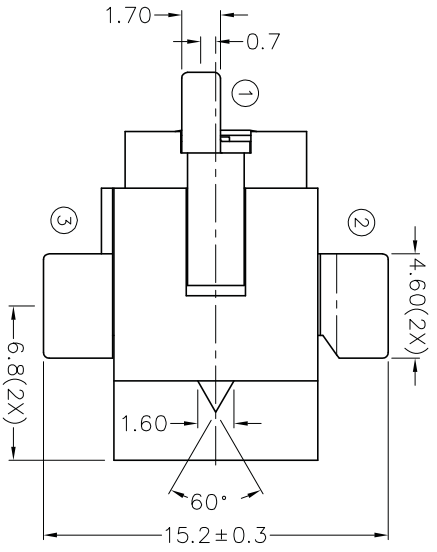
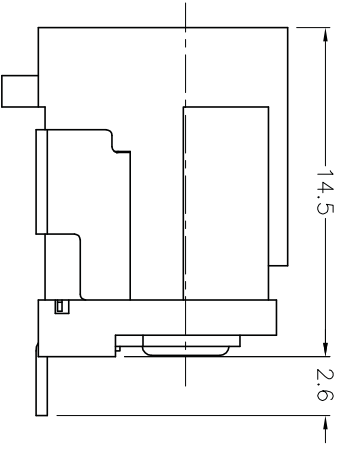
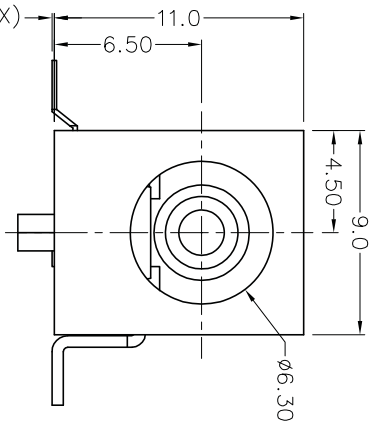
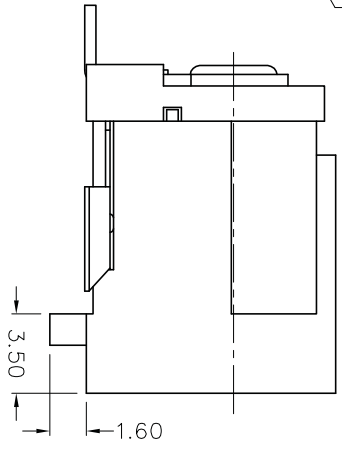
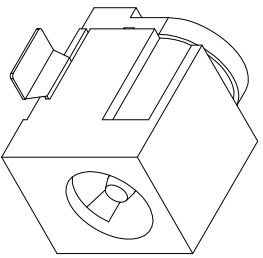

DC MATE PLUG

* MATERIAL
 CENTRE PIN : COPPER
 TERMINAL 1 : BRASS
 TERMINAL 2 : COPPER ALLOY
 TERMINAL 3 : BRASS
 HOUSING : PA6T
 COVER : PA6T

MODEL NO.	TDC-061D
SCHEMATIC	
CENTER PIN	φ2.5mm

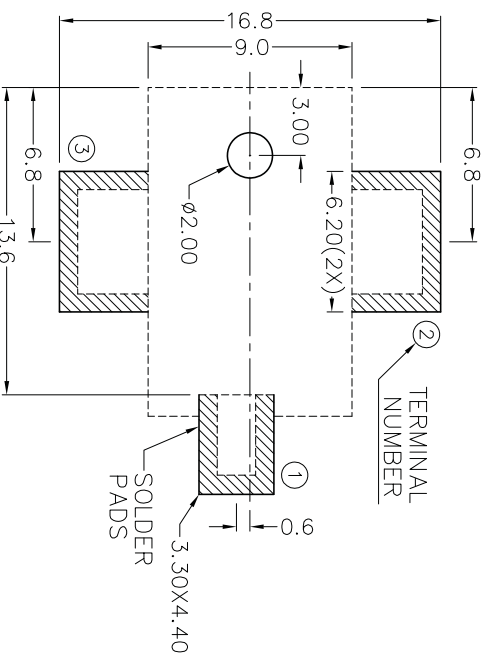

RECOMMENDED
SOLDER PAD LAYOUT



PART NAME	SMD DC POWER SOCKET	TOLERANCE UNLESS	0.0±0.2	UNIT:	mm
PART NO.	TDC-061D	OTHERWISE SPECIFIED:	0.000±0.05		

DESIGN	T.Y.LI	DATE	5-7-2005	SCALE	3:1
DRAWING	L.L.ZHANG	DATE	30-9-2006	MATERIAL	*
CHECK		DATE		DWG. NO.	ITZ\DC061D-PA6T/B
APPROVAL		DATE		SHEET	

F

E

D

C

B

A

DCF-04/A