

RoHS
Compliant

ZONE	SYMBOL	REVISION	APPROVAL	DATE
C4		MODIFY THE SCHEMATIC	J.X.KUANG	29-11-2006

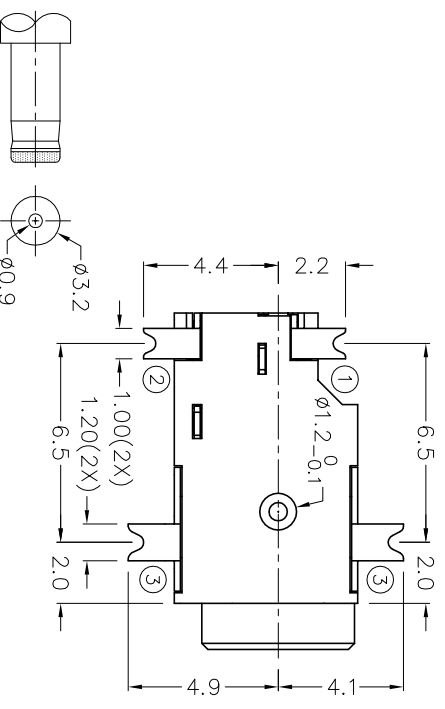
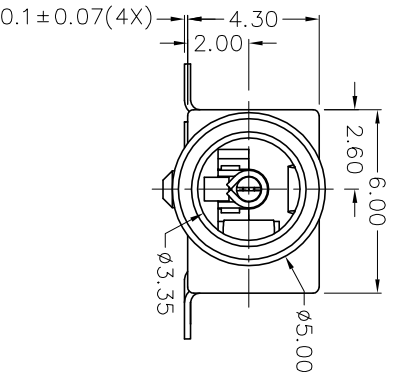
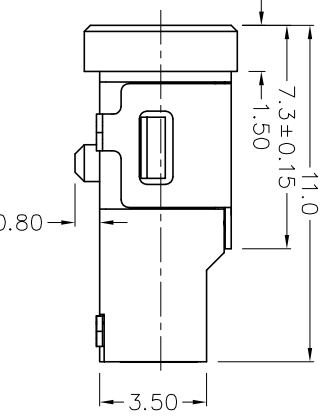
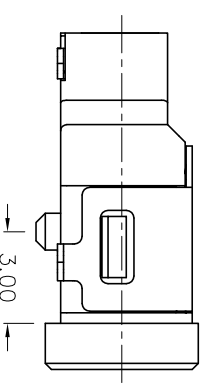
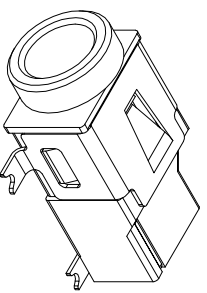
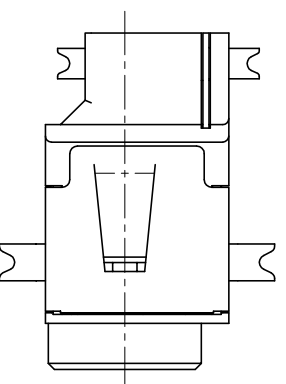

DC MATE PLUG

* MATERIAL
 TERMINAL 1 : BRASS
 TERMINAL 2 : COPPER ALLOY
 TERMINAL 3 : COPPER ALLOY
 HOUSING : PA6T

MODEL NO.	TDC-042D
SCHEMATIC	
CENTER PIN	Ø0.8mm

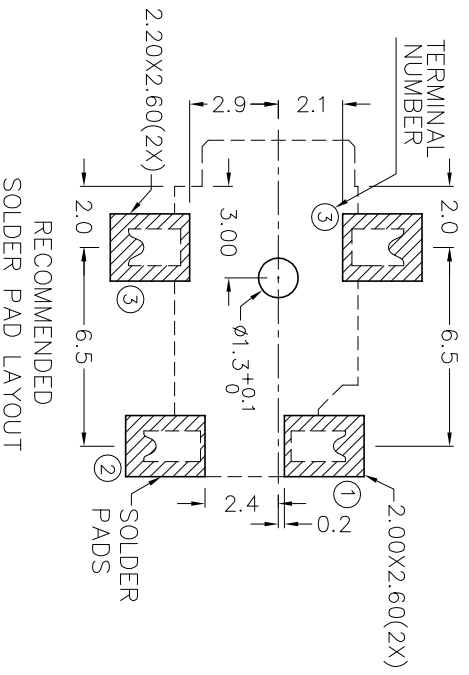

PART NAME		SMD DC POWER SOCKET		TOLERANCE UNLESS		0.0±0.2		UNIT:		mm	
PART NO.		TDC-042D		OTHERWISE SPECIFIED:		0.000±0.05		APPROVAL			
DESIGN		J.X.KUANG		DATE		19-5-2004		SCALE		4:1	
DRAWING		L.L.ZHANG		DATE		29-11-2006		MATERIAL		*	
CHECK				DATE				DWG. NO.		TZ\DC042D-PA6T/E	
APPROVAL				DATE				SHEET			
F		E		D		C		B		A	
JOYNet Enterprise Co., Ltd.		Technology		Professional		Service		DCF-04/A			